

# InFoPaK®

US PATENT 5,595,300

## MOUNTING INSTRUCTIONS

Thermoformed From Clear, 25 mil, PETE Plastic

Fully Recyclable 

One Piece Construction

Self Contained Snap Back Lid

Holds Approximately 200, 8-1/2 x 11 Flyers

Winner of Society Of Plastic Engineers' "TOP PROMOTIONAL PRODUCT" award

**"Our AWARD winning InFoPaK 3000 can be installed anywhere!"**  
InFoPeTe

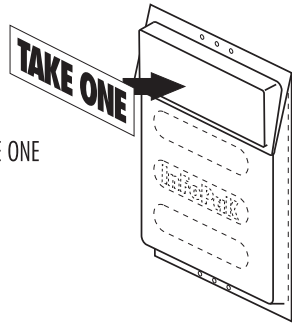
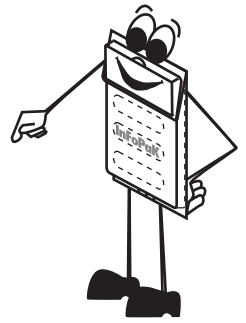

Peel back and affix "TAKE ONE" decal as shown.

Use the enclosed screws to install the InFoPaK on any wood post. Make sure to apply the screws through the upper AND lower holes, as illustrated.

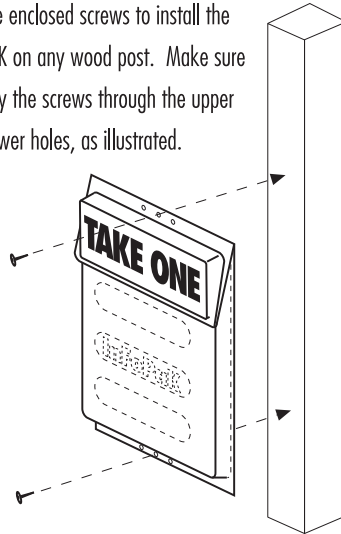

To use the enclosed permanent locking cable ties, thread through the pair of holes located at the top AND the bottom of the InFoPaK, wrap the cable ties around a pole or post and thread one end of the cable tie through the open end, then pull tight. See illustration.

NO TOOLS NEEDED.

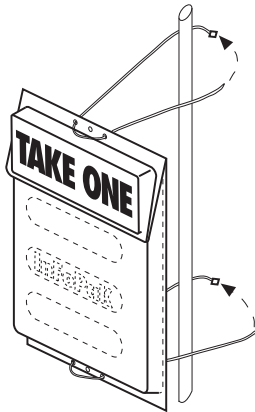

To attach the InFoPaK on any window or windshield, punch out keyhole tabs located on the back of the InFoPaK and insert suction cups\* as illustrated. For best results clean surface prior to attachment.

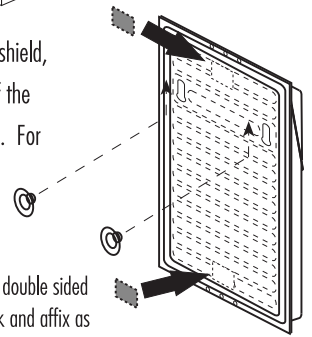

To mount with double sided tape, peel back and affix as illustrated.

\*Suction cups (part No. 0500) may be purchased separately. Do not drive with the InFoPaK attached to the car, intended to be used on parked vehicles only.



## "Take a look at our product line."

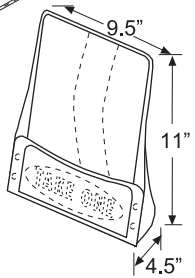

**5000 - InFoRAK**  
Designed to hold 8.5" X 11" brochures & flyers. Ideal for table top.

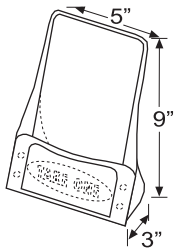

**4000 - InFoRAK Jr.**  
Designed to hold Tri-Fold & Half-Fold size brochures & flyers. Ideal for table top.

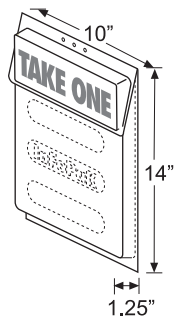

**3000 - InFoPaK**  
Outdoor flyer box, designed to hold 8.5" X 11" size brochures & flyers.

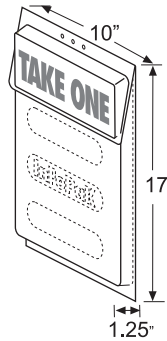

**3500 - InFoPaK LEGAL**  
Outdoor flyer box, designed to hold 8.5" X 14" legal size brochures & flyers.

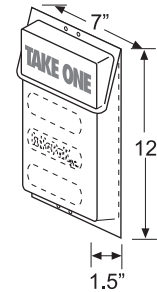

**2000 - InFoPaK Jr.**  
Outdoor flyer box, designed to hold Tri-Fold & Half-Fold size brochures & flyers.

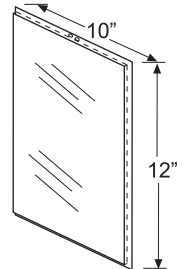

**1000 - InFoLeF**  
A single sheet wall display, and protector, designed for 8.5" X 11" brochure or flyer.

**InFoPaK International, Inc.**

PO Box 6808 Bend, OR 97708

1-800-973-1311

<http://www.infopak.com>

InFoPaK, InFoPaK JR and InFoLeF are registered trademarks of InFoPaK International, Inc. all rights reserved - [www.infopak.com](http://www.infopak.com)